

Ultrasonic Corrosion and Thickness Gauges



dmeq

QS5 Models B / DL / E / DLE

QS5 User Manual

Ultrasonic Corrosion and Wall Thickness Gauges

P/N: QSD 501 – ENG – Rev 3 – 2012

Index

Chapter 1		First Steps	
1.1	Know the QS5		1
	1.1.1	Front panel	1
	1.1.2	Connectors	2
1.2	Install or replace batteries		2
1.3	Connecting the transducer		5
1.4	The "Q" key		6
1.5	Display illumination and contrast		6
	1.5.1	Display backlight illumination	6
	1.5.2	Display contrast	7
1.6	Locking and unlocking the keypad		7
Chapter 2		Measuring with the QS5	
2.1	Numerical measure screen (Normal)		9
	2.1.1	Screen mode-1 (Min., Max.)	9
	2.1.2	Screen mode-2 (Percentage Value)	10
	2.1.3	Screen mode-3 (Datalogger)	11
2.2	Keys in numerical measure modes		11
2.3	BScan graphic measure screen		14
2.4	Keys in BScan graphic measure screen mode		15
2.5	Zero calibration (Auto)		15
2.6	1-Point and 2-Point calibration		17
2.7	Changing the material velocity		19
	2.7.1	Change to a known velocity	19
	2.7.2	Change velocity using a known thickness value	19
2.8	Adjusting trigger and gain		20
2.9	Understanding the coupling icons and the energy level indicator		21
	2.9.1	Coupling icons	21
	2.9.2	Coupling energy level indicator	22
2.10	Measuring thru-coating or thru-paint		25

Chapter 3 Menu system and editing

3.1	Instructions on using the menu system	28
3.1.1	Text editor	29
3.2	Main menu	31
3.2.1	Change measuring unit	31
3.2.2	Alarm settings	31
3.2.3	Set BScan range	33
3.2.4	Select language	33
3.2.5	Unit information	34
3.3	General configuration options	34
3.3.1	Set time and date	35
3.3.2	Set time and date format	35
3.3.3	Set keypad sensitivity	36
3.3.4	Set auto-off time	37
3.3.5	Adjust display contrast	37
3.3.6	Beep activation	38
3.3.7	Introduction screen	38
3.3.8	Owner information	38
3.3.9	Lock configuration options	40
3.3.10	Model upgrade licenses	41
3.3.11	Return to factory default settings	42
3.4	Measuring configuration options (Ultrasonic)	43
3.4.1	Set material velocity	43
3.4.2	Select measure mode	44
3.4.3	Adjust gain	45
3.4.4	Adjust trigger	45
3.4.5	Select refresh rate	45
3.4.6	Select transducer frequency	46
3.4.7	Select coating type	46
3.4.8	Select calibration mode	47
3.4.9	Hold last value	48
3.4.10	Energy level compensation (DAC)	48
3.4.11	Material condition analyzer	49

3.4.12	Nums Zoom measuring screen mode	50
3.4.13	Continuous measuring monitor	50
3.4.14	Adjust pulser excitation voltage	51
3.4.15	Return to factory default settings	52

Chapter 4 Using the Datalogger

4.1	Understanding how data is organized	53
4.2	Memory menu	53
4.3	Creating a file	54
4.4	Actions over single files	55
4.4.1	View data in a single file	56
4.4.2	The "Q" key in a grid	56
4.4.3	The "Q" key in a histogram	57
4.4.4	The "Q" key in a SCAN graphic	59
4.4.5	Send data from a single file	60
4.4.6	Rename a file	60
4.4.7	View file size	60
4.5	Actions over all files	60
4.5.1	Send all files	61
4.5.2	Erase all files	61
4.6	The Datalogger in the measuring screen	62
4.6.1	Datalogger information	62
4.6.2	Quick memory menu (Mem key)	63
4.7	Connecting to a PC with DataCenter	64
4.8	Datalogger configuration	65
4.8.1	Configure communications	65
4.8.2	Capture modes	66
4.8.3	Set number of values	67
4.8.4	Selecting fixed batch	67
4.9	Advanced Datalogger configuration	68
4.9.1	Store every (N) number of values	68
4.9.2	Record operator actions	68
4.9.3	Record date and time	69

Appendix

Tips on how to measure correctly

Technical specifications

Additional information

Unit maintenance

QS5 accessories

Error messages

Our website: www.demeq.com

Technical support

Thank you choosing dmq

And thank you for purchasing a QS5 ultrasonic corrosion and wall thickness gauge.

Company Statement

At dmq we develop, manufacture and distribute software and quality control instruments offering innovation and solutions that come as a direct result of listening to your needs as a user. We apply some of the latest technology available in the industry to build instruments that are robust, precise, and easy to operate.

We are convinced that our products would not be complete without permanent technical and after sales support. So in addition to a great product we offer:

- Quick answers to your inquiries.
- Unlimited access to technical information as well as application notes.
- Special offers for registered customers.
- Firmware and software upgrades at no charge.
- Attention to your inquiries and suggestions.

We hope that the QS5 will meet and exceed your application needs.

General information

Models included in this manual

The information included in this manual applies to all QS5 series ultrasonic corrosion and wall thickness gauges including models B, DL, E and DLE.

Registered trademarks

dmq is a registered trademark of demeq S.R.L and its affiliate companies.

Important notice

The information contained in this manual is intended to educate users on the operation of the QS5 gauges. Failure to read and understand this manual can lead to measurement errors. Decisions based on measurements and or results that are erroneous can lead to property damage, personal injury or even death. Demeq S.R.L assumes no responsibility as a result of the improper use of our instruments.

Applicable standards

- ASTM E797

User training

The user must be trained in ultrasonic testing procedures and on how to properly configure the unit for testing. All of the following should be taken into consideration:

- Understand the theory on sound wave propagation.
- Select the instrument as well as the transducer that is best suited for your application.
- Know the specific requirements for the test you will be conducting.

This manual provides all of the information needed to configure and operate the QS5 gauge. However there are additional factors that can

affect tests done with this instrument. Specific information on those factors is outside the scope of this manual. When in doubt you should always seek expert advice or refer to specific textbooks on ultrasonic testing. Additional information can also be found on the internet and through local government agencies as well as in technical institutes.

Measuring Principle

The QS5 operates with dual crystal transducers that use the “pitch-catch” principal. Dual crystal transducers use two piezoelectric crystals whereby one crystal is excited with short electrical pulses from the unit sending short acoustic waves into the test piece. The second crystal then receives the acoustic waves reflected at the end of the test piece. The frequency of the acoustic waves changes between 2 and 10 MHz depending on the probe being used.

All QS5 gauges operate in Echo-1 or normal (no coat) mode where a measurement is the result of the sum of the time delay from the transducer and the time it takes for the acoustic wave to rebound back to the transducer after it reaches the end of the test piece. In Echo-2 or thru-paint mode (QS5 E and QS5 DLE only), the unit measures the time interval between the first and second echoes and does not take into consideration the time delay from the transducer.

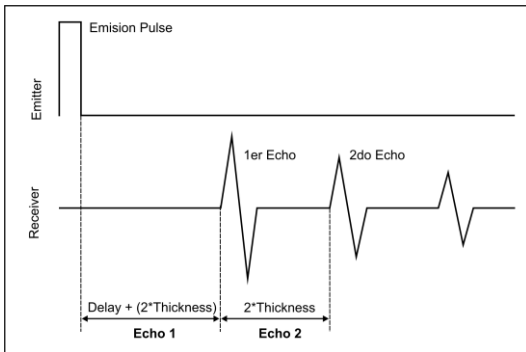

Figure 1: Echo-1 and Echo-2 mode acoustic wave representation**Testing Limitations**

In ultrasonic testing information is obtained from measuring sound waves. Users must be very careful when making assumptions in regards to the entire test piece condition when there are areas that have not been inspected. In large and massive test pieces it would be practically impossible to test the entire piece and therefore conclusions for the whole piece based solely on the areas that have actually been inspected, should only be done by experienced operators. Only trained users should evaluate test pieces that could present erosion and or corrosion.

Critical Operating Procedures

In order to minimize test result errors the following must be observed:

1. Zero calibration

Before taking actual measurements the unit and transducer have to be calibrated. Calibration of the transducer is also known as zero calibration or delay calibration (*Page 15*). If the unit and transducer are not calibrated, or calibrated incorrectly, the resulting measurements will be unreliable. Each and every time a transducer is changed it must be calibrated to the unit.

2. Material sound velocity calibration

Because the sound velocities in materials will often vary significantly from published values, best results are obtained when the instrument is calibrated on a reference test block made from the same material as that of the actual test piece. The block should be flat, of a smooth finish, and be as thick as the maximum thickness of the test piece.

Careful consideration by the user must be made when evaluating the accuracy of a thickness value because considerable changes in the sound velocity of a material may have occurred as a result of a treatment. So for example a test piece made of steel that has been thermally treated, will look the same as a regular test piece made of

untreated steel, but the sound velocities vary significantly. Instruments should be calibrated before and after testing to minimize errors.

3. Transducer selection

Transducers must be in good condition and show no visible signs of excessive wear or defects on their surface. Badly worn transducers can provide erroneous measurements.

The thickness of the material being tested must be within the specified thickness range of the transducer and the temperature of the material must also be within the specified temperature range of the transducer.

4. Use of couplants

Calibration as well as actual testing should be performed under similar coupling conditions. Couplant must be applied in an even and consistent manner to minimize variations in couplant layers that may result in testing errors. The amount of couplant should be kept to a minimum and consistent pressure should be applied on the transducer when measuring.

5. Conditions under which "Doubling" may occur

Doubling refers to a thickness measurement that displays a reading that is twice or even three times the real test piece thickness. Doubling often may happen when trying to measure below and above the specified range for the transducer and when using worn transducers. When in doubt, the test piece thickness must be measured using other methods and or instruments and the unit must then be calibrated using reference test blocks of known thickness values that are made of the same material as the actual test piece. This is very important when measuring unknown test pieces for the first time.

6. How temperature may affect calibration

When possible calibrate your instrument on-site using a test block that is at the same temperature as the test piece in order to minimize errors.

Important Safety Information

All QS5 series corrosion and thickness gauges are for industrial use only and cannot be used in medical applications. The QS5 operates on two AA size batteries. We strongly recommend that you use only top brand name alkaline batteries.

Disposal of your QS5 gauge and its components must be done in compliance with all applicable regulations.

About the Software

Because of its complexity level, software is never really completely error free. For this reason in software controlled instruments always make sure that the operations required for your application are in correct working order.

Warranty

Demeq S.R.L provides a limited warranty for a period of 2 (two) years on electronic units and for 6 (six) months on transducers from the date of purchase and may be extended for up to 5 years.

Every instrument undergoes thorough testing during manufacturing as well as before shipping. In the event warranty service where to become necessary, dmq and or your local distributor or representative will make a reasonable effort to replace your defective unit with another new or used unit, while your instrument undergoes warranty repair.

1 First steps

1.1 Know the QS5

1.1.1 Front panel

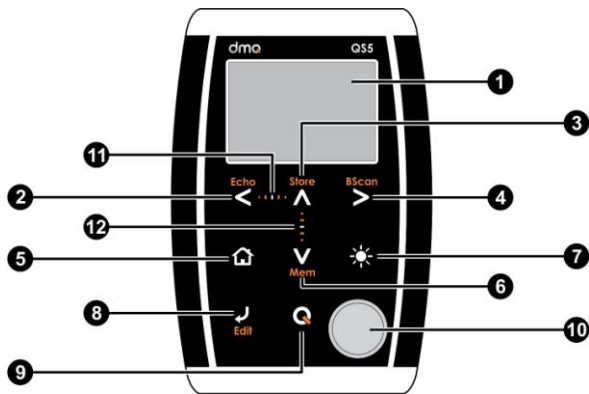

Figure 1.1: Front of the unit

1. Graphic LCD display with LED backlight illumination
2. Move Left key / Switch measuring modes: normal measurements or Echo-1 / Thru-Paint or Echo-2 (Echo)
3. Move Up key / Manually store a value (Store)
4. Move Right key / Switch to graphical measure mode screen (BScan)
5. Menu key / Enter and exit measure screen / Exit and return to menus (Home)

6. Move Down key / Quick access to memory menu screen options (Mem)
7. Change backlight illumination key (On, Off, Auto)
8. Enter key / Edit values on the measure screen (Edit)
9. The **Q** key: Power On and Shutdown (touch and hold for 2 seconds) / Make quick and short touches to activate special functions and features
10. Calibration disk
11. Horizontal scrolling center point (lock and unlock keypad on measure screen)
12. Vertical scrolling center point (adjust LCD contrast)

1.1.2 Connectors

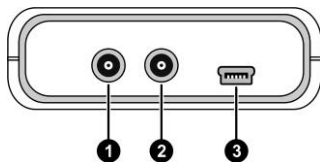

Figure 1.2: Unit connectors

1. Receiving transducer connector (Type Lemo 00)
2. Emitting transducer connector (Type Lemo 00)
3. USB mini connector to connect to PC using a USB cable (supplied with the unit)

1.2 Install or replace batteries

The QS5 is powered by 2 (two) AA batteries that are placed in the battery compartment located in the back of the unit. To access to the battery compartment slide the cover as shown in figure 1.3-1 and gently push the extraction ribbon upward and slightly towards the right to release the batteries (figure 1.3-2).

When you install new batteries, first insert the positive end of each battery so that it coincides with the positive pole inside the battery compartment as you see in figure 1.4-1. Always leave the extraction ribbon underneath the batteries.

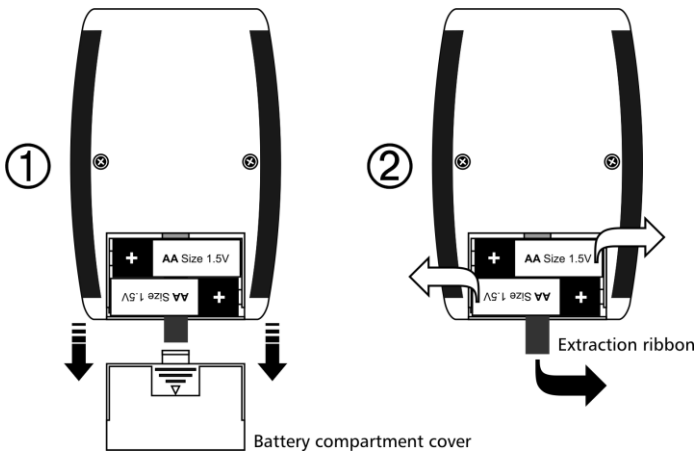

Figure 1.3: Removing batteries

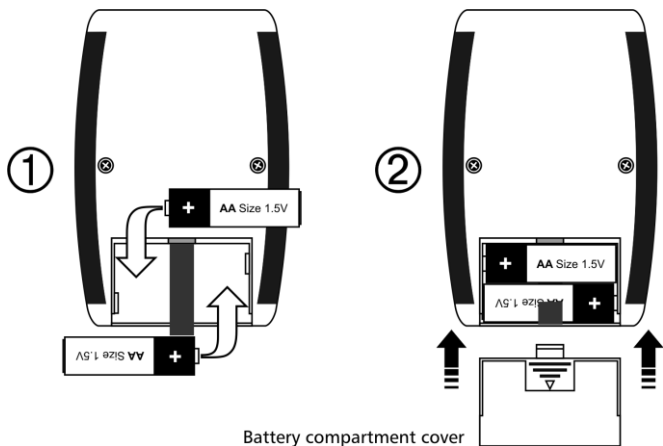
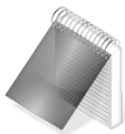

Figure 1.4: Replace / Insert batteries



Notes

Use new alkaline top brand batteries only.

Do not mix new and old batteries. Always replace both batteries.

Rechargeable batteries type NiMH can be used but will result in less time of continuous operation.



Important

Do not remove batteries while the unit is powered as this may affect the Datalogger (See *Appendix: "Additional information, Error Messages"*)

1.3 Connecting the transducer

The QS5 has two type Lemo "00" connectors located on top of the unit. Because this is the standard for most dual crystal probes, you could basically connect any probe to your QS5. Keep in mind that the gain may need to be adjusted when changing probes.

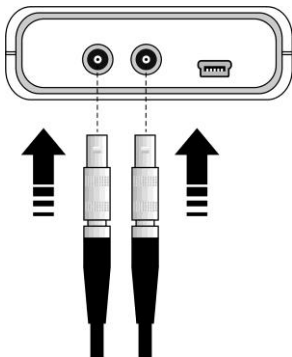





To connect the probe, simply align any of the male connectors located at the end of the transducer cable to any of the female connectors located on the gauge and press gently until connected.

To release the probe hold the knurled section on the male connectors and pull gently away from gauge until released.

Figure 1.5: Connecting the transducer

1.4 The “Q” key

The  has three functions:

- When the unit is off, touch  for 2 seconds to power on the unit.
- When the unit is on, touch  for 2 seconds to shutdown the unit.
- With the unit on, making short touches to the  will activate special functions described in later chapters of this manual.

1.5 Display backlight illumination and contrast

Backlight illumination and contrast options can be changed from any screen in the unit.

1.5.1. Display backlight illumination

Touch  to change the backlight illumination settings.

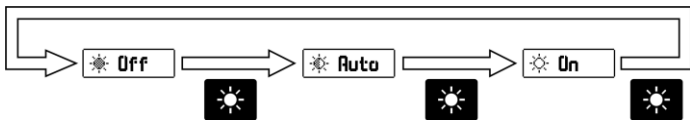
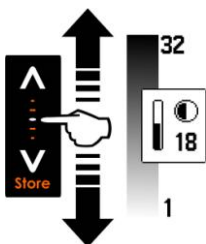

Figure 1.6: Backlight illumination options

1.5.2. Display contrast



The display contrast on all dmq units is digital. Touch the white dot located in the center of the vertical scrolling bar between the **▲** and **▼** keys and a contrast window will open. Move your finger towards the top and or bottom of the dotted line to adjust the contrast on your display.

Figure 1.7: Display contrast adjustment

1.6 Locking and unlocking the keypad

To lock the keypad place your finger on the white dot located in the center of the horizontal scrolling bar between the **◀** and **▲** keys. Move your finger to the right following the dotted line and a window on the unit display will open with the word Lock. Continue moving your finger in the same direction until you enter locked mode. The window on the display will close and the locked keypad indicator will show on the top right of the unit screen.

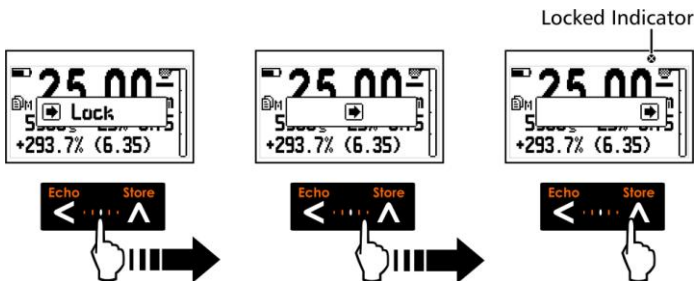

Figure 1.8: Locking the keypad

Sliding the finger to the left will unlock the keypad.

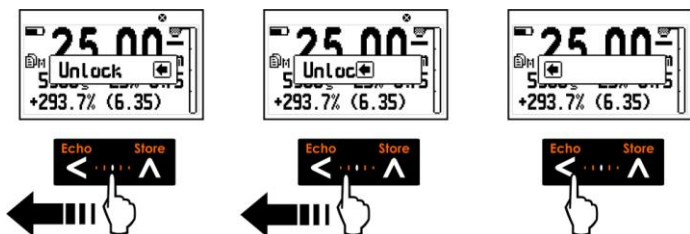

Figure 1.9: Unlocking the keypad



Important

The keypad can only be locked and unlocked in the measuring screens.

2 Measuring with the QS5

The QS5 can display measurements in 3 distinct numerical measuring modes or screens each one showing specific information. To switch numerical measure screens touch the **Q** key.

2.1 Numerical measure screens (Normal)

2.1.1 Measure screen mode-1 (Min. and Max. values)

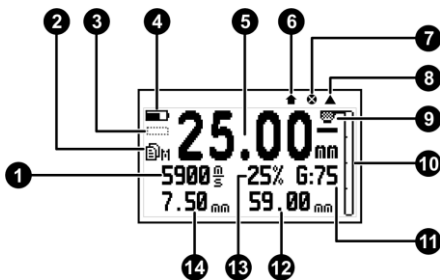



Figure 2.1: Measure screen mode-1

1. Material velocity
2. Datalogger mode indicator (Page 62)
3. Measured value signal in differential measuring mode (Page 44)
4. Battery level indicator
5. Thickness value in the selected unit
6. Icon indicating that a value was stored
7. Locked keypad icon indicator (Page 7)

8. Inactive calibration disk indicator (Page 16)
9. Coupling level indicator / material condition analyzer (Page 21)
10. Echo energy level indicator (Page 22)
11. Gain level (Page 20)
12. Maximum measured value
13. Trigger level (Page 20)
14. Minimum measured value



Note

Touching the  once will reset maximum and minimum values to zero and touching it again will display the measure screen in mode-2 described next.

2.1.2 Measure screen mode-2 (Percentage value)

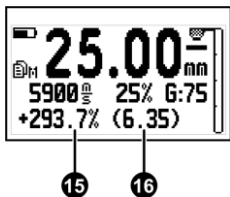

15. Percentage value as compared to the nominal value
16. Nominal value (represents 100% of the percentage value)

Figure 2.2: Measure screen mode-2

2.1.3 Measure screen mode-3 (Datalogger)

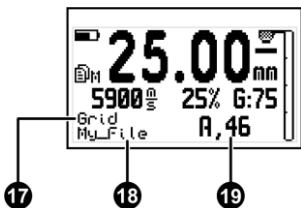

Figure 2.3: Measure screen mode-3

17. Data storage modes (Grid / SCAN)
18. Name of open file where data is being stored (Page 53)
19. Position within the grid of the last stored value (Column, Row)

2.2 Keys in numerical measure modes

In all three numerical measure screen modes the following applies in terms of keypad functionality:

Echo (Left Arrow): Touch once to switch from Echo-1 to Echo-2. Touch again to switch back to Echo-1 (the Echo key is active only in QS5 E and QS5 DLE models).

Store (Up Arrow): Touch to manually store the measurement in the memory.

BScan (Right Arrow): Touch to switch to real time graphic BScan mode.

Home (Home Icon): Touch to exit the measure screen and enter the main menu.

Mem (Down Arrow): Touch to view quick memory access options.

 : Touch to activate the Select / Edit mode. Four flashing arrows will appear over the fields of measurement, velocity, trigger and gain.

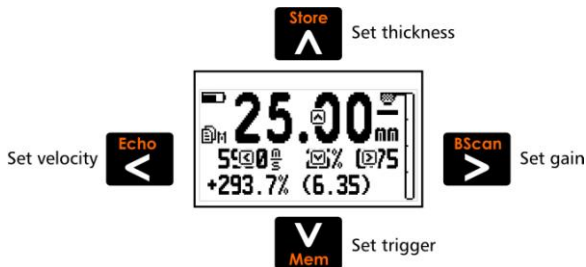









Figure 2.4: Measuring screen in select / edit mode

- To select thickness measurement touch 
- To select material velocity touch 
- To select trigger touch 
- To select gain touch 

Always use the   keys to edit the values in any given field and touch  to save.

Trigger and gain can be edited while measuring. This allows you to see the new thickness value (resulting from the changes made earlier to the trigger and gain settings) to be displayed immediately.





Note

The measurement field can only be edited if an actual measurement was taken. If the measurement is 0.00 this field cannot be edited.





Tips

Touch the  when editing velocity and a screen will appear with the most commonly used materials and their velocities. Use the cursor keys to scroll the list and touch  to select or touch  to exit and return to the edit velocity field.

When a measurement was taken and the velocity is changed, a new measurement is automatically displayed that reflects the change in velocity.

 : Short touches allow you to switch between the three measure screen modes. Touch for 2 or more seconds to shutdown the unit.

 : Changes the backlight illumination.

 : Adjust display contrast.

 : Lock and unlock the keypad.

2.3 BScan graphic measure screen

The QS5 allows you to view measured values in real time graphics.

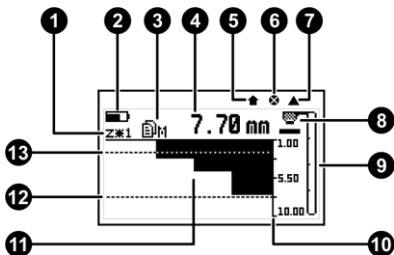

Figure 2.5: BScan graphic

1. Zoom level
2. Battery level indicator
3. Datalogger mode indicator (Page 62)
4. Thickness value in the selected unit
5. Icon indicating that a value was stored
6. Locked keypad icon indicator (Page 7)
7. Inactive calibration disk indicator (Page 15)
8. Coupling level indicator / material condition analyzer
9. Echo energy level indicator
10. Vertical thickness reference axis in the graphic
11. BScan graphic area
12. High alarm setting (Page 31)
13. Low alarm setting (Page 31)

2.4 Keypad functions in BScan graphic mode

Keypad functions in the BScan graphic mode are the same as in the numerical measure screen modes (Page11) except for the following keys:



: Go to the numerical measure screen mode



: Short touches will zoom in / out of the graphic. Touch for 2 or more seconds to shutdown the unit.

2.5 Zero calibration (Auto)

The QS5 uses a zero (delay) calibration procedure that is activated by simply coupling the transducer over the calibration disk located in front of the unit.

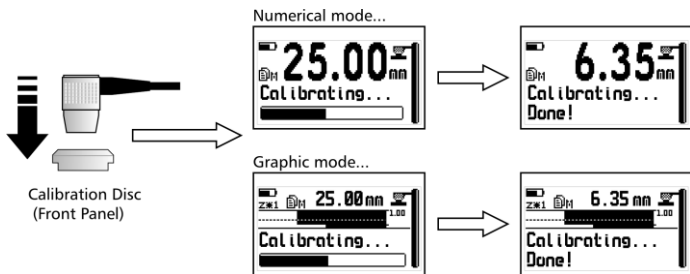

Figure 2.6: Zero calibration procedure

When this automatic procedure ends, the unit is calibrated to measure steel which is the default material velocity used in this calibration method.

**Tip**

In order to measure the thickness of the calibration disk without activating the automatic calibration procedure simply touch the edge of the disk until an icon appears as shown in (*Figure 2.1, 8. Inactive calibration disk indicator, Page 9*) While still touching the edge of the disk, couple the transducer to obtain its thickness measurement. When the transducer is coupled you no longer need to touch the edge of the disk.

2.6 1-point and 2-point calibration

In order to obtain precise measurements, especially when exchanging transducers, the QS5 can be calibrated with your own test piece samples. To access the two calibration modes available on the QS5, go to the **Ultrasonic** menu (page 43) and enter the **Calibr.** option. Select **2-Points** and follow the procedure below for calibration:

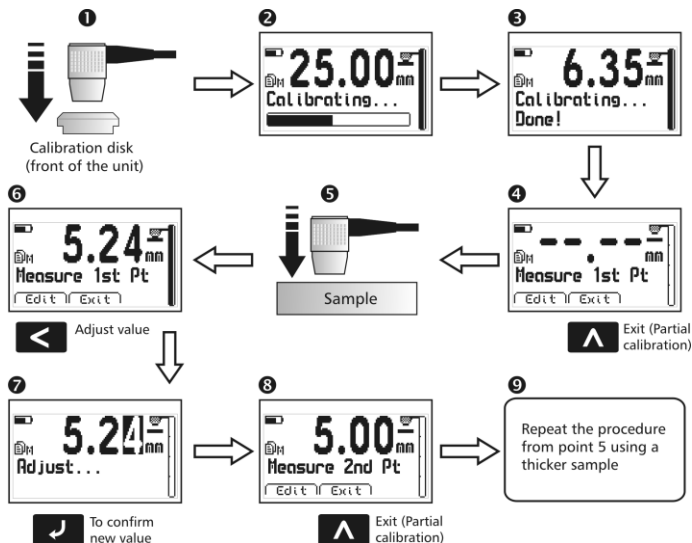







Figure 2.7: One point and two point calibration procedure

1. Measure using the calibration disk located in the unit front panel.

The unit will proceed with the automatic calibration procedure and “Calibrating” will be displayed on the unit

screen. When the calibration is done, the unit will display "Calibration... Done!". At this point the unit will ask that you measure the first test piece sample "Measure 1st Pt." and two additional options will be displayed: **Edit** and **Exit**.

2. Touch  (Exit) to end the calibration using just the unit calibration disk, or measure the first test piece sample.
3. After a measurement is displayed touch  (Edit) to edit the value using the cursor keys so that it matches the actual test piece thickness.
4. When you are done editing the measurement, touch  to save and the unit will ask "Measure 2nd Pt.".
5. When a measurement is displayed for the second test piece simple, touch  (Edit) to edit the value using the cursor keys so that it matches the second test piece simple thickness. When you are done editing the measurement, touch  to end the 2-point calibration procedure.

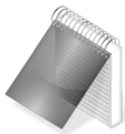

Notes

In the 2 point calibration procedure, the thickness of the 1st point (first test piece sample) **MUST** be lower than the thickness of the second test piece sample.





The unit assumes that the material velocities of the test piece samples are the same and that the correct velocity has been set in the unit before the calibration procedure was initiated.

Use of the unit calibration disk does not change the velocity set by you.

2.7 Changing the material velocity



2.7.1 Change to a known velocity

If you know the velocity of the material you will be measuring you can manually enter the velocity by doing the following:

- Go to any numerical measure screen mode. If you are in graphic BScan mode touch  (BScan) to switch to normal mode.
- Touch  from any numerical measure screen to enter the Select / Edit mode.
- Touch  to edit the velocity field.
- Use the cursors to set the velocity and touch  to confirm or touch  to cancel.







Tip

Touch the  when editing velocity and a screen will appear with the most commonly used materials and their velocities. Use the cursor keys to scroll the list and touch  to select or touch  to exit and return to the edit velocity field.

2.7.2 Change velocity using a known thickness value

If you do not know the velocity of the material but you know the material thickness you can set the velocity using the material thickness value by doing the following:

- Measure the material for which you already know the thickness.
- Lift the transducer and touch  to enter the Select / Edit mode.

- Touch  to select the thickness measurement field.
- Use the cursors to set the thickness value and touch  to confirm or touch  to cancel.

When editing the thickness value observe that the velocity will change accordingly.

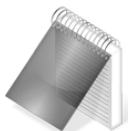

Note

When changing the material velocity using a known thickness value the unit must have already been calibrated for the transducer being used (*Page 15*).

2.8 Changing trigger and gain

The QS5 has two controls (Trigger and Gain) that have a direct impact on the ultrasonic signal process so that any dual crystal transducer can be used and optimized for best performance.

The following image shows you how to interpret changes done to the trigger level represented in higher and lower trigger values.

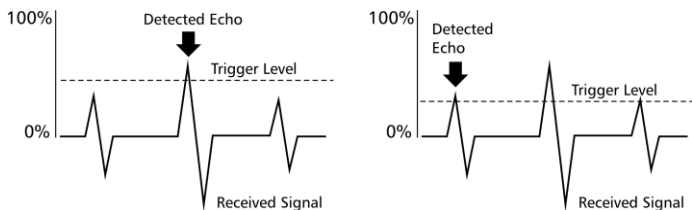

Figure 2.8: Representation of high and low levels of trigger

The image below shows how you to interpret changes done to the gain level represented in higher and lower gain values:

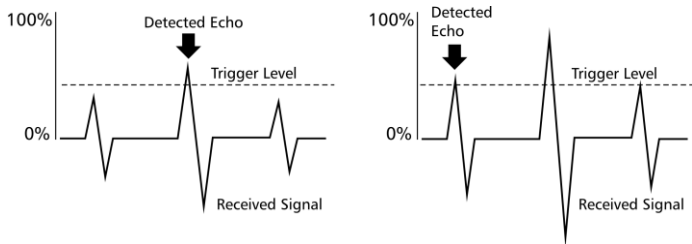

Figure 2.9: Representation of high and low levels of gain

The trigger level determines the echo signals detected by the unit. A higher trigger means lower sensitivity where only larger echoes are detected. The gain level works like a “volume control on an audio device”, the higher the gain setting the more amplified the echoes will be.

A low trigger and a high gain are ideal in obtaining good sensitivity, but if the trigger is set too low or the gain too high “noises” are generated in the transducer that can result in erroneous or unstable measurements. Transducers that are defective, badly worn or of poor quality will also produce noises.

2.9 Understanding the coupling icons and the energy level indicator

2.9.1 Coupling Icons

By default the unit always indicates whether the transducer is coupled (measuring) or if the transducer is not coupled (in the air). But when the analyzer option located in the Ultrasonic menu (page 47) is

activated the unit now also alerts the operator on the possible condition of the test piece being measured. When the material condition analyzer - available exclusively from dmq - is enabled, the QS5 can display any of the following coupling icons:

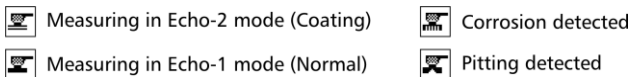

Figure 2.10: Coupling icon representations

The analyzer only works in Echo-1 mode. When measuring in Echo-2 or thru-paint mode the coupling icon will simply indicate that you are measuring in that mode (represented with two parallel lines).



Important

Material defects that are represented by the coupling icons serve only as a warning and should not be interpreted as definitive results. The specific area where the possibility of a material abnormality is detected should then be further inspected to confirm or discard the warning.

2.9.2 Coupling energy level indicator

The vertical bar located on the far right side of the measuring screen shows the echo signal intensity or energy level received by the transducer giving you valuable information such as:

- The coupling condition between the transducer and the test piece.
- The reflective (bottom) test piece surface condition where low energy levels would typically indicate the possible presence of corrosion or pitting.

- The material attenuation level that allows the operator to detect metal treatments that have an effect on the ultrasonic characteristics of a material.

The QS5 has two modes for representing the energy absorbed by the transducer:

No DAC: Shows only the energy level as provided by the transducer

With DAC: Compensates the energy level based on the measured thickness. Use DAC to detect material conditions such as thermal treatments and test piece defects easier regardless of the measured thickness. DAC is activated in the Ultrasonic menu (*page 47*).

The higher the energy level reflected from the test piece bottom, the higher the energy level will be on the vertical bar. This is an indication of good coupling.

Low energy indicates any of the following: poor coupling (not enough coupling gel), high attenuation materials (treated metals and some plastics), an irregular test piece bottom surface (possible corrosion or pitting) or if DAC is disabled it may be reflecting the test piece thickness.

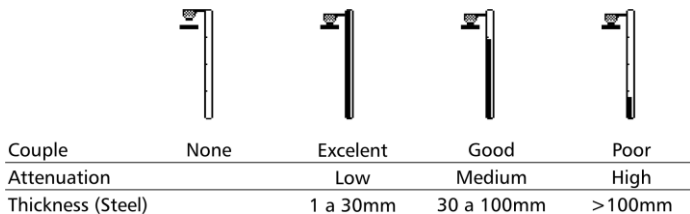

Figure 2.11: Vertical bar energy level representations



Tips

Sudden intensity losses usually mean that there are defects in the test piece related to corrosion or pitting.

When measuring thick test pieces with DAC turned off, the energy level decreases because a greater distance (thickness) usually results in more attenuated echoes being received by the transducer.

When a test piece made of steel that will typically return high energy levels, is returning low energy, this usually means that it was subject to thermal treatment. To confirm or discard this possibility, measure the velocity of the test piece. Steel that has been thermally treated will have a different material velocity.

In case of low energy levels always make sure you have good coupling and that you used enough coupling gel to avoid erroneous interpretations.

When measuring in Echo-2 or thru-paint the energy level may be low because the unit uses the energy produced by the second echo which is normally smaller and more attenuated when compared to the first echo used in normal Echo-1 measurements.

2.10 Measuring thru-coating or thru-paint (QS5 E and QS5 DLE)

The QS5 E and QS5 DLE gauges can measure thru-coatings such as paint or epoxy so you no longer need to scrape and remove the coating in a test piece. The unit now “skips” the coating and measures only the actual test piece thickness.

To enable thru-coating or thru-paint mode (Echo-2) touch the  (Echo) key from the measuring screen and the unit will display the mode you are in. (Echo-1 normal, or Echo-2 coating (thru-paint)).

Switch between Echo modes touching  and wait until the window indicating the mode you are in disappears. This means that the unit is now set for the Echo mode you selected.

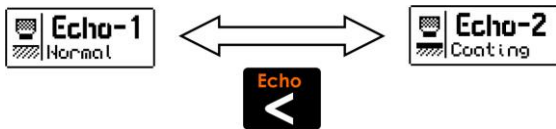

Figure 2.12: Change of Echo windows (normal or coating)

Multi-echo units use separate ultrasonic configurations for each echo mode. This means that when switching between Echo-1 and Echo-2 modes the gain, trigger and voltage of the pulse emission are maintained for each mode. In the example below the gain level for Echo-1 is 75 and for Echo-2 it is 63. These gain levels will not change as you switch modes.

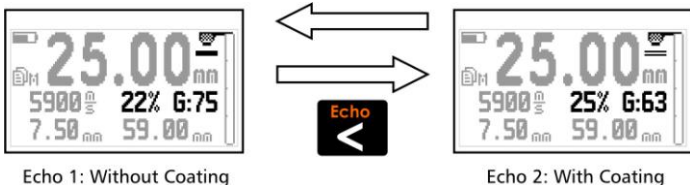

Figure 2.13: Ultrasonic settings on each echo mode

All unit menu screens display an icon indicating the echo mode that the unit is operating in.

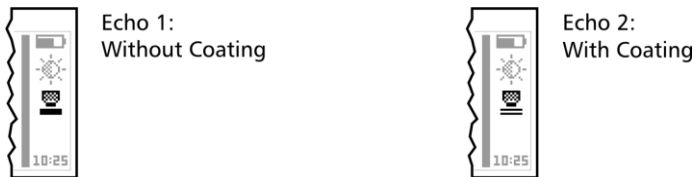

Figure 2.14: Echo mode icon in menu screens

In Echo-2 mode the unit does not need to be calibrated and calibration is actually blocked because when operating with multiple echoes the delay in the transducer does not affect the thickness measurement.

To obtain precise and reliable measurements in Echo-2 mode the following considerations and limitations should be considered:

- The test piece coating should not exceed 2mm. This may vary according to the attenuation of the coating material.
- The thickness of the actual test piece should not exceed 25mm.

- Lose or poor adherence between the coating and the test piece can result in scattering of ultrasonic waves making it impossible to measure.
- Use sufficient coupling gel for stable coupling in order to avoid erroneous or incorrect readings.
- Always use dmq hi-damp transducers to measure in Echo-2 mode. Standard probes will not work correctly in this mode.

3 Menu system and editing

3.1 Instructions on using the menu system

The instructions explained in this chapter apply to all of the menus in the unit.

To scroll QS5 menu options use the **▲** - **▼** cursor keys. When you reach the end of the menu and move to the next menu option it becomes circular as shown below.

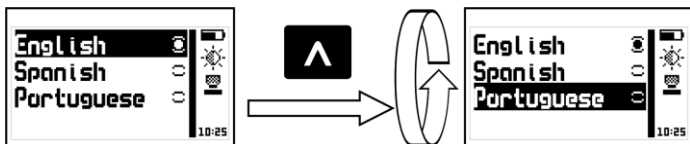

Figure 3.1: Example of how a circular menu works

To select a menu option touch **↩** and to exit and return to the previous menu touch **🏠**. To go to the measuring screen touch **🏠** from the main menu.

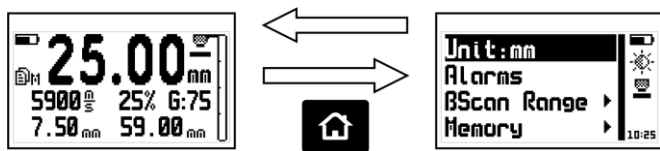

Figure 3.2: The “Home” key from the measuring screen

3.1.1 Text Editor

The text editor is used to input, change, and delete; letters, numbers and symbols.



Figure 3.3: Alphanumeric editor screens

1. Selected key
2. Cursor
3. Text to be edited
4. Virtual keyboard

Use the cursor keys on the unit to scroll the virtual keyboard until you find the character you want to use and touch  to select.

Touch  to move to the upper case virtual keyboard and to the numbers and symbols keyboard as seen on figure 3.3.

There are 4 keys that are common to all virtual keyboard screens:

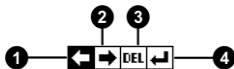

Figure 3.4: Common virtual keyboard keys

1. Move cursor to the left
2. Move cursor to the right

3. Erase the character on which the cursor is on
4. Enter and exit

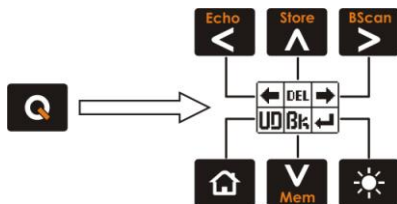









Figure 3.5: Quick access keys for the virtual keyboard editor

Touch the  key to open the quick access keyboard to the most commonly used virtual keyboard keys. Each virtual key corresponds to a key on the front panel of the unit as follows:

- : Move the cursor to the left
- : Erase the character on which the cursor is on
- : Move the cursor to the right
- : Undo
- : Erase the character to the left of the cursor
- : Enter and exit

To close the quick access keyboard and continue using the virtual keyboard touch .

3.2 Main menu





The main menu is the first list of options that appears when you exit the measure screen and it includes the most important settings. Touch  from the measuring screen to access this menu.

Figure 3.6: Main menu

Note: The options of Configure, Ultrasonic and Memory are explained later on in this manual.

3.2.1 Change measuring unit

Unit

Touch  on **Unit** in the main menu to open the list of available units.

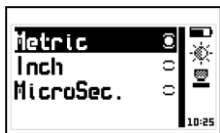

Use the  -  keys to scroll the menu.



Touch  to select the unit and touch  to save and exit this menu.

Figure 3.7: Units menu

3.2.2 Alarms Settings

Alarms

The QS5 has high and low alarms that alert the operator when the measurement is greater than the value set for the high alarm and or when the measurement falls below the value set for the low alarm.

Touch  on **Alarms** to open the alarm menu options.

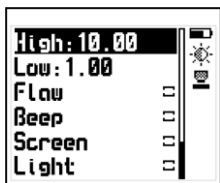

Touch  on **High** or **Low** to open the numbers editor where you can set alarm values using the cursor keys.

Touch  to save the alarm value that you entered and to return to the previous menu.

Figure 3.8: Alarms menu options

Any of the following alarm types can be selected:

Flaw: The alarm is activated when the material condition analyzer detects the presence of a possible defect such as corrosion or pitting. Enabling this option will activate the Analyzer (*page 49*).

Beep: Audible intermittent alarm type.

Screen: Visible alarm that causes measurements to be displayed in dotted instead of regular numbers.

Light: Visible alarm that activates the display backlight illumination causing it to flash.

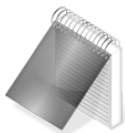

Note

The material condition analyzer operates only in Echo-1 mode. In Echo-2 or thru-paint mode the flaw alarm is automatically disabled.

3.2.3 Set BScan Range

BScan Range

Here you can set high and low values (thickness range) that will be represented on the vertical axis of the graphic BScan measure screen.

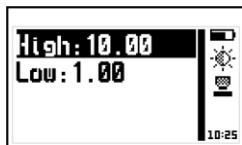

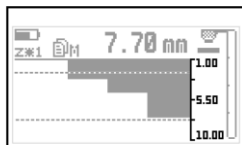

Range adjust menu



Range representation in BScan graphic

Figure 3.9: BScan range and graphic representation

Touch  on **BScan Range** to open the menu.

Touch  on **High** or **Low** to open the numbers editor where you can set a value using the cursor keys. Touch  to save and return to the previous menu.

3.2.4 Select language

Language

Touch  on **Language** (which is also identified with a flag) to view available language options.



Use the cursor keys to scroll available language options and touch  to select.



Touch  to save and exit this menu.

Figure 3.10: Language menu options

3.2.5 Unit information

Unit Info

Select **Unit Info** to view information including owner data as well as the software version that your unit is running.

To view different unit information screens touch the   keys.

To return to the main menu touch .

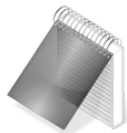

Note

The information required to obtain model upgrade licenses is included in this option.

3.2.5 General configuration options

Configure

Touch  on the **Configure** option to open the general configuration options menu.

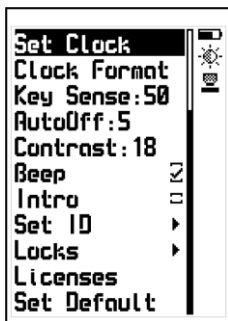

Use the   keys to scroll the menu.

Touch  to select any of the menu options.



Touch  to exit and to return to the previous menu.

Figure 3.11: General configuration options menu

3.3.1 Set time and date

Set Clock

Choose **Set Clock** to open the time editor and use the cursor keys to set the time. Touch  to save and to enter the date editor screen. Set the date and touch  to save and exit.

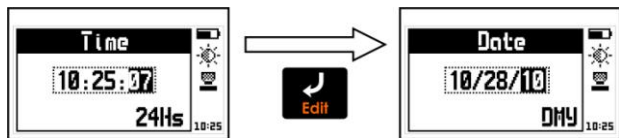
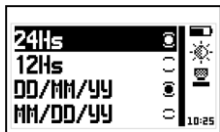

Figure 3.12: Time and date editing screens

3.3.2 Set time and date format

Clock Format

Choose **Clock Format** to open the menu that allows you to set the time format (12Hs or 24Hs) and the date format (D/M/Y – M/D/Y).









Touch  on the option you wish to select and touch  to save and exit.

Figure 3.13: Date and time format menu options

3.3.3 Set keypad sensitivity

Key Sens.

This option allows you to set the keypad sensitivity. The higher the number is that you set here, the more sensitive the keypad will be.

Touch  on **Key Sens.** and use the - keys to change the keypad sensitivity. Touch  to save and the keypad will already be working with the new sensitivity level.

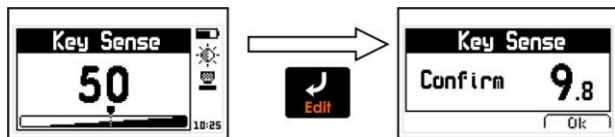



Figure 3.14: Key sensitivity and confirmation screens

To confirm the change in sensitivity touch . If you touch any other key or the counter that appears on your screen reaches 0.0, the sensitivity will return to its previous setting.

The factory default setting is 50. Under special conditions we suggest that the sensitivity level be changed.



Tips

If the unit will be operated using security gloves we recommend that the sensitivity level be raised.

To make the keypad “harder” simply lower the sensitivity level.

In applications where the front of the unit may be exposed to water and or vapors the sensitivity should be lowered.



3.3.4 Set auto-off time

AutoOff

The unit will shutdown automatically if no key is touched or no measurement is made when you set the auto-off time.

Touch  on **AutoOff** to set the time before the unit automatically shutdown.



Touch the   keys to set the time and touch  to save and exit.





Touch  to exit without making changes.

Figure 3.15: Auto-off time setting screen

3.3.5 Adjust display contrast

Contrast

Use this setting to adjust the screen contrast making it lighter or darker where 1 is the lightest and 32 is the darkest.

Touch  on **Contrast** and use the   keys to change the contrast on your screen.

Touch  to save or touch  to exit without making changes.

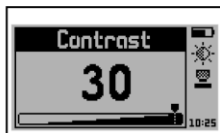

Figure 3.16: Screen contrast settings



Tips

Contrast on LCD screens can change with temperature. Use the contrast option to compensate for changes caused by temperature in order to maintain optimal viewing conditions.

3.3.6 Beep Activation

Beep

Beep refers to the sounds that the unit makes when keys are touched and when the audible alarm is activated.

Touch  to enable or disable the beep option.

3.3.7 Introduction screen

Intro



The introduction screen is the first screen that you would see (if this option is enabled) after the unit is turned on. It includes owner information such as name, telephone number and e-mail.

Touch  to enable or disable this option.

3.3.8 Owner information

Set ID

This option allows you to enter owner information (the info that would appear on the introduction screen).

Touch  on **Set ID**, enter the password (the factory default password is 12345) and touch  to access user info menu options.

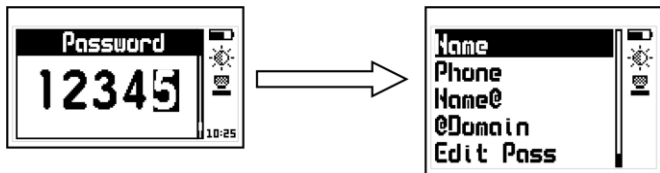

Figure 3.17: Enter password to access the user info menu

The user information that can be added or changed at anytime includes the following:

Name: Set or change the owner name.

Phone: Set or change the telephone number.

Name@: Set or change the e-mail (before the @).

@Domain: Set or change the domain for the e-mail (after the @).

Edit Pass: Allows you to change the password needed to access this menu.

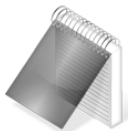

Notes

When showing user information, the e-mail address is displayed as "Name@Domain".





Important

The factory default password is 12345. You can change this password after adding your user information.

3.3.9 Lock configurations

Locks

Certain configuration options on your QS5 unit can be locked in order to avoid unwanted changes. Use of the locking options allow a supervisor to optimize unit configuration settings required for a specific test and then pass the unit on to an operator for him or her to conduct the actual measurements knowing that the unit has been properly configured and that the settings cannot be changed.

Touch  on Locks, enter your password and then touch  again to view the configuration options that can be locked.

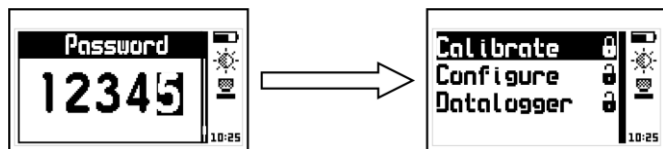

Figure 3.18: Enter password and options lock menu

Each option is followed by a lock indicating whether the feature is locked (closed lock) or unlocked (open lock).

Touch  on each of the following options to lock or unlock:

Calibrate: Lock or unlock unit calibration options.

Configure: Lock or unlock ultrasonic configuration options (trigger and gain).

Datalogger: Lock or unlock Datalogger configuration options.

3.3.10 Model upgrade licenses

Licenses

Q55 models can be changed with software licenses that you can purchase from dmq. If you want to purchase an upgrade license we will need to know the following information:

- Unit model
- Unit serial number
- The type of license that you would like to purchase





Touch  on **Licenses** to view all licenses available for your unit (checkmarks indicate active licenses).

Figure 3.19: Licenses screen

To enter the new license number that you purchased from dmq touch  or to exit and return to the previous menu touch .



Use the cursor keys to enter the license number and touch  to save.

Figure 3.20: Enter new license number screen

After you enter the new license number the unit will respond with one of the following messages:



Wrong register password message



Success register password message

Figure 3.21: Response messages after a license is entered

If the license number that you entered is correct the unit will show an updated license screen where the newly purchased license appears followed by a checkmark.

3.3.11 Return to factory default settings

Set Default

Choose **Set Default** to return to the original factory default general configuration options.

Touch  and a confirmation screen will appear.





Touch  to confirm and return to the previous menu or touch  to exit without making changes.

Figure 3.22: Set factory default settings confirmation screen

3.4 Measuring configuration options

Ultrasonic

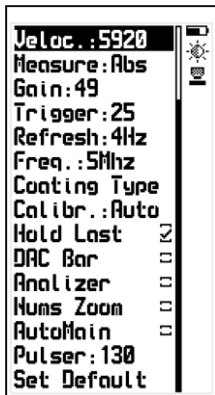

Select **Ultrasonic** from the main menu to display measuring configuration options.



Setting these options correctly is critical in attaining reliable measurements.



Figure 3.23: Measuring configuration options menu

3.4.1 Set material velocity

Veloc.

Touch  on the **Veloc.** option to change the material velocity so that it matches the material that will be measured.

Use the cursor keys to change the velocity and touch  to enter. To exit without making changes touch .

Touch the  when editing velocity and a screen will appear with a list of the most commonly used materials and their velocities. Use the cursor keys to scroll the list and touch  to select or touch  to exit and return to the edit velocity field.

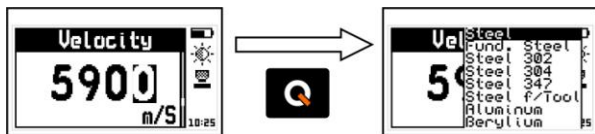



Figure 3.24: Change material velocity and material velocity list

3.4.2 Select measure mode

Measure

Touch  on Measure to open the measure modes options menu.

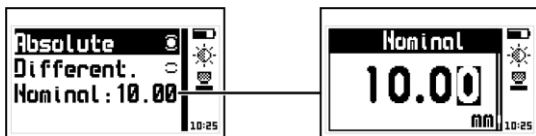

Figure 3.25: Measure mode options menu and set nominal value



The modes in which measurements are represented are:

Absolute: the unit displays the real measured value

Different.: the displayed value is the result obtained from calculating:



$$\text{Differential} = \text{Real value} - \text{Nominal value}$$

Where the nominal value is a reference value for the test piece

Touch  on **Nominal** to set this value and touch  to save. To exit without making changes touch .

3.4.3 Adjust gain



Gain

Touch  on **Gain** to change this value and touch  to save. To exit without making changes touch .

For additional information on setting the gain refer to "Changing trigger and gain" (page 20).

3.4.4 Adjust trigger

Trigger

Touch  on **Trigger** to change this value and touch  to save. To exit without making changes touch .



For additional information on setting the gain refer to "Changing trigger and gain" (page 20).

3.4.5 Select refresh rate

Refresh

Touch  on **Refresh** to open the refresh rate options menu (the speed in which measurements will be taken).



Use the   keys to scroll menu options and touch  to select.

To exit without making changes touch .

Figure 3.26: Refresh rate speed options

The factory default for this setting is 4 Hz (4 measurements per second) which is enough for most applications. When looking for additional details or for scanning a specific test piece section we recommend switching to higher refresh rates.



Notes

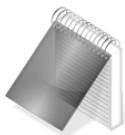

A higher refresh rate increases energy consumption therefore reducing battery life.

Storing measurements in the Datalogger at high speeds means the size of the memory is reduced a lot quicker. Measuring at 20Hz over one minute is equal on average, to 1200 measurements.

3.4.6 Select transducer frequency

Freq.

Touch  on **Freq** to open the transducer frequency rate options menu.

Use the   keys to scroll menu options and touch  to select.

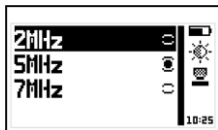



To exit without making changes touch .

Figure 3.27: Transducer frequency options

Most standard transducers are 5MHz. When a different frequency transducer is used you should select the correct frequency in this menu.

3.4.7 Select coating type

Coat Type

Touch  on **Coat Type** to open the menu options for the attenuation level of the coating type when measuring in Echo-2 or thru-coating.



Use the **▲** **▼** keys to choose any of the two available menu options and touch **↩** to select. To exit without making changes touch **🏠**.

Figure 3.28: Type of coating options

To measure thru-coatings that are less than 1mm thick, select the **Low Loss** option. For high attenuation coatings such as epoxy (typically used in shipyards) and for coatings greater than 1mm thick, select the **High Loss** option.

Even though the coating type option is available for all QS5 models this setting only affects the QS5 E and QS5 DLE models that can operate in Echo-2 mode or thru-coating.

3.4.8 Select calibration mode

Cal.

Touch **↩** on **Cal.** to open the unit calibration menu options in the measuring screen.



Use the **▲** **▼** keys to choose any of the two available menu options and touch **↩** to select. To exit without making changes touch **🏠**.

Figure 3.29: Unit calibration menu options

The QS5 has two calibration modes:

Auto: Calibration is automatically done when coupling the transducer using the calibration disk located in the front of the unit (*page 15*).

2-Point: Calibration is done with one or two test piece samples of a known thickness, and made of the same material that you will be measuring (*page 17*). The 2-Point calibration will usually result in more precise thickness measurements.

3.4.9 Hold last value

Hold last

When you enable the **Hold last** option the last measured value will be displayed on the unit screen even when the transducer is not coupled. When hold last is disabled and the transducer is not coupled the unit display will read "--.--".

Touch  to enable or disable this option.

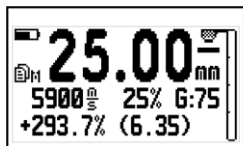

Hold Last mode off

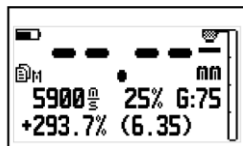

Hold Last mode on

Figure 3.30: Measuring screens with hold last enabled or disabled

3.4.10 Energy level compensator (DAC)

DAC Bar

When the **DAC Bar** option is enabled the unit compensates the energy level on the vertical energy bar based on measured thickness (*page 22*). When this option is disabled the energy level on the vertical bar is shown just as provided by the transducer.

Touch  to enable or disable this option.

3.4.11 Material condition analyzer

Analyzer

Enable **Analyzer** so that the unit will alert the operator on the presence of possible defects with icons that appear on the measuring screen (page 21). When the analyzer option is disabled the coupling icon only indicates whether the transducer is coupled (measuring) or not coupled (in the "air").

Touch  to enable or disable this option.



Important

Material defects that are represented by the coupling icons serve only as a warning and should not be interpreted as definitive results. The specific area where the possibility of a material abnormality is detected should then be further inspected to confirm or discard the warning.



Note

Activating the flaw alarm (page 32) will automatically enable the analyzer option.

3.4.12 Nums Zoom measuring screen mode Nums Zoom

When **Nums Zoom** is enabled the numerical measuring screen displays thickness measurements in larger numbers and only the velocity and minimum value are displayed. The minimum value is reset by touching the  key.

Touch  to enable the Nums Zoom option and touch again to disable.

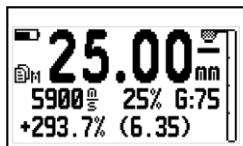

Regular View



Nums Zoom View

Figure 3.31: Normal and Nums Zoom numerical measure screens

3.4.13 Continuous measuring monitor AutoMain

When **AutoMain** is enabled the unit continuously monitors the transducer so that when the transducer is coupled it automatically switches to the measuring screen regardless of the menu you are in.

Touch  to enable or disable this option.



Note

Enabling the continuous measuring monitor slightly increases battery consumption. By default this option is disabled.

3.4.14 Adjust pulser excitation voltage

Pulser

Touch  on **Pulser** to adjust the transducers pulser excitation level.

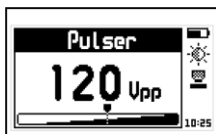





Touch the   keys to adjust the tension and touch  to save and exit. To exit without changes touch .

Figure 3.32: Transducer pulser excitation tension editor screen

Just like with the trigger and gain settings the pulser tension is set separately for Echo-1 and Echo-2 modes.

Considerations when adjusting the pulser excitation tension:

Higher excitation or tension levels mean that more energy is applied to the emissions crystal in the transducer making it easier to measure in high attenuation and large or thick materials.

When measuring small or thin materials high tensions produce saturated echoes that can affect measurement results particularly when operating in Echo-2 mode.

Avoid high tensions particularly when using small diameter transducers as this could damage the transducer. For 5MHz transducers the tension should not exceed 150V. Large diameter transducers of a lower frequency can be set to higher tensions for better performance.

3.4.15 Return to factory default settings **Set Default**

Choose **Set Default** to return to the original factory default ultrasonic configuration settings.

Touch  and a confirmation screen will appear.





Touch  to confirm and return to the previous menu or touch  to exit without making changes.

Figure 3.22: Set factory default settings confirmation screen

4 Using the Datalogger

4.1 Understanding how data is organized

In order to optimize the use of the Datalogger in your QS5 DL and QS5 DLE it is important that you understand how data is organized.

In the QS5 data is stored in 8 individual files with alphanumeric names. Each file contains a grid with columns and rows. And each grid contains columns (identified with consecutive letters; A, B, ...AA, AB...) that store an "N" number of values or measurements (batch). Each value is identified with a column letter and a row number.

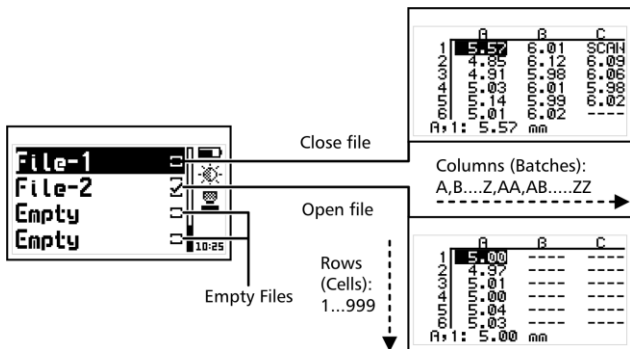
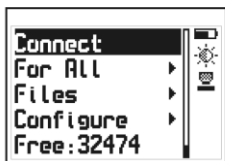

Figure 4.1: How data is organized in the Datalogger

4.2 Memory menu

Memory

Select **Memory** from the main menu to view all menu options for the Datalogger. The options in this menu will be different depending on your QS5 model. The QS5 B and QS5 E store values that can only be viewed on the unit screen but cannot be sent to a PC or a printer.



Memory menu for QS5 DL/DLE

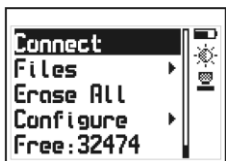



Memory menu for QS5 B/E

Figure 4.2: Memory menu options based on unit model

4.3 Create a file

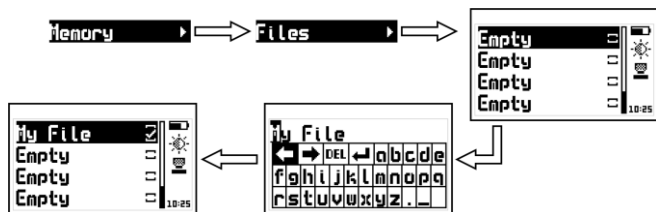
Touch  on **Files** and use the cursor keys to navigate the list of files in the unit.

Figure 4.3: Creating a file

Select a file that appears as **Empty** (available file) and touch  to name the file with up to 10 alphanumeric characters.

After you enter a name a checkmark will appear next to it meaning that a new file has been created and is ready to be used.

Remember that only one file can be open at any given time so whenever a new file is created, if a file was already open, the file that was open will be closed. Once a file has been closed, it cannot be reopened and new values can no longer be stored. In closed files, values can only be viewed.

Whenever you create a new file, and another file is already open, a warning screen will ask if you want to close the last file.





Touch  to confirm that you want to close the open file to create (open) a new one or touch  to cancel and return to the menu.

Figure 4.4: Close file confirmation screen

4.4 Actions over single files

Touch  on any closed file and a menu will open that displays options for that file.



Figure 4.5: Single file menu options

4.4.1 View data in a single file

View Data

	A	B	C
1	5.00	---	---
2	4.97	---	---
3	5.01	---	---
4	5.00	---	---
5	5.04	---	---
6	5.03	---	---
R: 1:	5.00	mm	





Touch  on **View Data** to view the contents of the file. Touch  to exit the file.

Figure 4.6: File view in a grid format

To move inside the grid use the cursor keys.

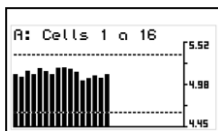

Touch  on a value to open a histogram that includes that same value as well as the values included in the foregoing cells within that column.





Touch  to exit and return to the grid.

Figure 4.7: Histogram representation

High and low alarm values appear in the histogram as dotted horizontal lines.

4.4.2 The Q key in a grid

Touch  to open the quick access menu that allows you to go directly to a position inside the grid.

Select the **Row**, **Column**, and **Cell** using the    keys.

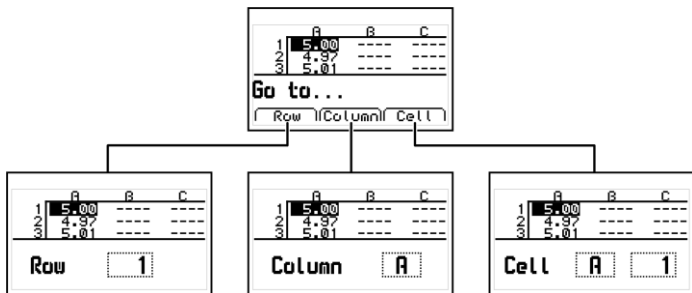





Figure 4.8: Quick access menu options in a grid

Row: Enter a row number using the cursor keys so that when you touch  the grid will position itself directly on that row.

Column: Enter the column letter using the cursor keys so that when you touch  the grid will position itself on that column.

Cell: This is a combination of (column and row) so that you can go to a specific cell after you enter the row number and column letter.

4.4.3 The Q key in a histogram

Touch the  key in the histogram to open the quick access menu that allows you to obtain statistical information on the batch of values being displayed.

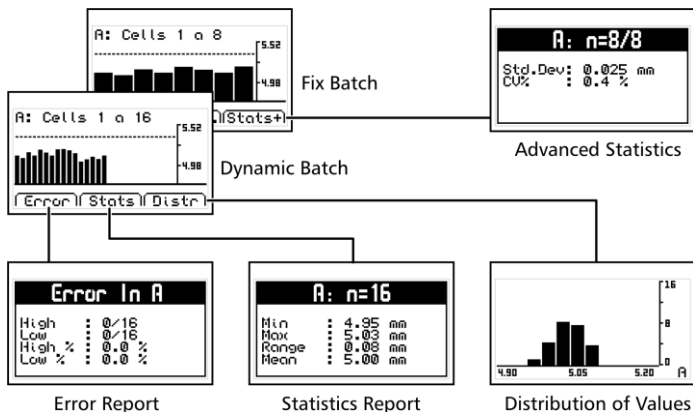

Figure 4.9: Quick access menu options in a histogram

Error: Displays the number of errors and error percentage values in the batch based on the high and low alarm settings.

Stats: View statistical information for the batch including Min., Max., Range and Mean values.

Stats+: View the standard deviation and the percentage (coefficient variation) for the batch.

Distr: Displays the distribution of values for the batch in a graphic format (dynamic batch).

4.4.4 The Q key in a SCAN graphic

Touch **Q** on a SCAN cell to open the quick access menu that allows you to easily move inside the scan and to view statistical information on the scan.

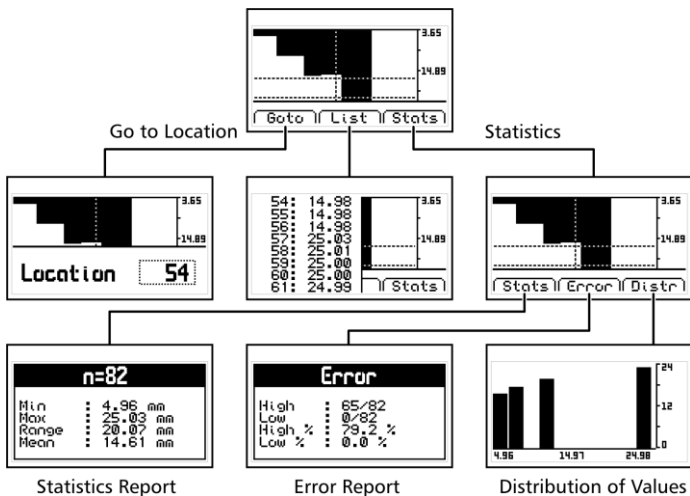

Figure 4.10: Quick access menu in a scan graphic

Goto: Access a specific position within the scan by entering its location (List).

List: Opens the list of measured values in the scan (use the **▲** - **▼** to scroll)

Stats: View the options of Stats, Error and Distr.

Stats: View statistical information including Max., Min., Mean and Range of all values within that SCAN cell.

Error: Displays the number of errors and error percentage values in the scan based on the high and low alarm settings.

Distr: displays the distribution of values for the scan in a graphic format.

4.4.5 Send data from a single file

Send

Touch  on **Send File** to send (units with Datalogger only) a single file to a PC using Windows HyperTerminal, or to a printer using an RS232 connection. This option does not work in USB mode.

4.4.6 Rename a file

Rename

Touch  on **Rename** to open the text editor that allows you to change the file name.

4.4.7 View file size

Size

Touch  on **Size** to view the number of stored values within a single file (and the size of the file as a percentage of total unit memory). You can also view the date and time in which the file was created.

4.5 Actions over all files

ALL Files





Touch  on **All Files** to open the menu for actions that will affect all files stored in the unit memory.

Figure 4.11: Actions over all files menu

4.5.1 Send all files

Send ALL

Touch  on **Send All** to send (units with Datalogger only) all files stored in the unit memory to a PC using Windows HyperTerminal, or to a printer using an RS232 connection. This option does not work in USB mode.

4.5.2 Erase all files

Erase ALL

The **Erase All** action permanently deletes all files stored in the unit memory and recovers 100% of the memory capacity.

Before files are deleted, a screen will be displayed asking you to confirm or to cancel this action.

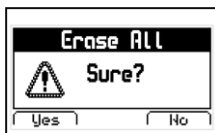



Touch  to cancel and return to the previous menu or touch  to begin deleting all files.

Figure 4.12: Erase all confirmation screen

When the erase all action has been confirmed the following screens will be displayed:

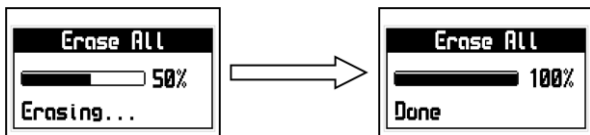

Figure 4.13: Erase all progress screen

4.6 The Datalogger in the measuring screen

4.6.1 Datalogger information

The QS5 Datalogger measure screen includes information and options to assist you in storing data.

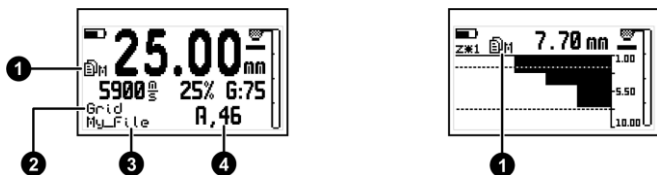



Figure 4.14: Information in the Datalogger measure screen

1. Datalogger status indicator icon  followed by any of the following letters:

X	Datalogger is disabled (no open file)
M	Manual capture mode
U	Single auto capture mode
C	Continuous auto capture mode
S	SCAN block capture mode
2. Storage type (Grid or SCAN). If measurements are being stored in a grid, "Grid" will be displayed. When a SCAN is stored the display will read "Scan: N" where N is the position of the scan block in the grid.
3. Name of the open file
4. Position of the stored value within the grid (Column, Row)



Notes

The Datalogger status indicator can be viewed on all QS5 measure screens as well as in the graphic screen. If no file is open the Datalogger will display “No File” and the unit will automatically switch to the Min. Max. numerical measure screen mode.

4.6.2 Quick memory menu (Mem key)

Touch **V** on the measuring screen to open the quick memory menu.

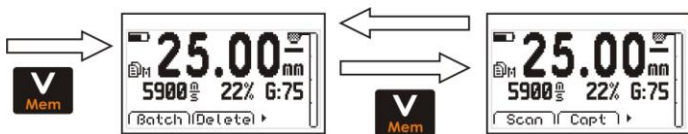

Figure 4.15: Quick memory menu options

In each quick memory menu screen two options are displayed at the bottom of each screen. To access these options use the **<** **^** keys. The **>** key maintains its normal functionality and the **V** key is used to switch quick screens as seen on figure 4.15.

Options in the first quick memory screen:

Batch: Close the open batch and open a new one.

Delete: Erase the last stored value

Options in the second quick memory screen:

Scan: Opens a SCAN block. If one is already open no action will be made.

Capt: Changes the capture modes (Manual – Single – Continuous). Allows you exit the Scan mode as well.

4.7 Connect to a PC with DataCenter

Connect

Touch  on **Connect** to enter the “waiting to connect” mode.

Touch  to exit and cancel the connection.

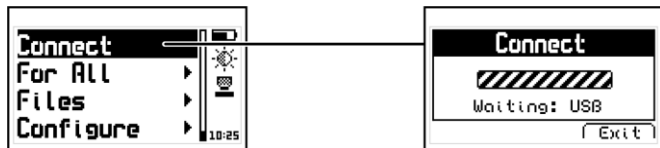

Figure 4.16: Connecting to a PC

With the unit in “waiting to connect” make sure that the USB or the RS232 cable (depending on the type of connecting cable that you are using) is properly connected to both the unit and the PC and click on <Connect> in DataCenter.

When a successful connection is established the files in your unit memory will appear in DataCenter. To view their contents simply double click on each file.

For additional information on dmq DataCenter software refer to the manual included in the CD that you received with your QS5 or download the manual at <http://www.demeq.com/Download.html>

4.8 Datalogger configuration

Configure

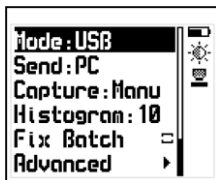

In the memory menu touch  on **Configure** to open the Datalogger configuration options menu.

Figure 4.17: Datalogger configuration options menu

4.8.1 Configure communications

The first two options in the configure Datalogger menu are **Mode** and **Send** which allow you to select how the unit will communicate with a PC or a printer.

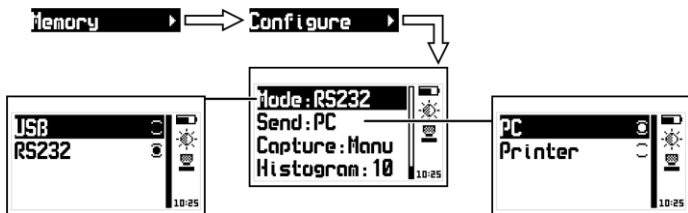



Figure 4.18: Configure communications options

Touch  on **Mode** to select the type of connection.

USB: Select USB to connect to a PC using a USB cable (included). You must already have DataCenter installed in your PC.

RS232: Select RS232 to connect to a PC or a printer using an RS232 cable (optional).

Touch  on Send to select whether you will send files to a PC or a printer.

PC: When using an RS232 cable, the unit sends data in an optimal format for Windows HyperTerminal (38400-8-N-1).

Print: Using an RS232 cable and printer, the unit sends data in an optimal format for mini-printers of 40 columns (9600/8-N-1).

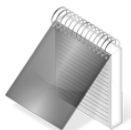

Notes

The print option can only be used with RS232 printers. Files cannot be sent directly to a USB printer.

When you use DataCenter to connect, your selection of PC or Print will not affect communication.

4.8.2 Capture modes

Capture:



Touch  on Capture to select the mode in which values will be stored in the Datalogger.



Figure 4.19: Memory capture modes menu

The QS5 has the following capture modes:

Manual: Touch the  key to store values.

Single: Each time the transducer is coupled a thickness measurement is stored. In this mode values can also be stored using the  key.

Continuous: When the transducer is coupled thickness measurements are continuously stored at a rate of:

Refresh / N

Where refresh refers to the number of values per second that the unit reads (*Page 45*) and N refers to the **Store Every** (N number of values) that can be set on the **Advanced** Datalogger menu options (*Page 67*).

4.8.3 Set number of values

Histogram

Touch  on **Histogram** to set the number of values for each batch when the **Fix Batch** option is enabled.

4.8.4 Selecting fixed batch

Fix Batch

When the **Fix Batch** option is enabled the unit automatically closes a batch and opens a new one when the number of values that you set for the histogram is reached. When the **Fix Batch** option is disabled values are stored until the batch is manually closed. You can close a batch by entering the “Batch” option by touching the “Mem” key while you are in the measuring screen.

Touch the  key to enable or to disable the **Fix Batch** option.

4.9 Advanced configuration

Advanced

Touch  on **Advanced** to access the advanced configuration options menu for the Datalogger.

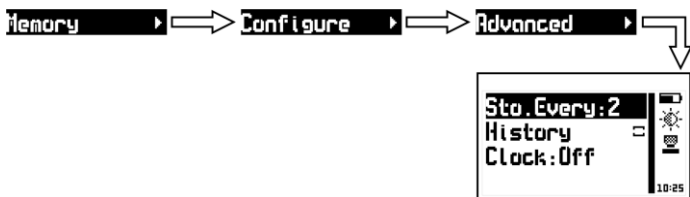



Figure 4.20: Advanced Datalogger configuration options menu

4.9.1 Store every (N) number of values



Store Every

Touch  on **Store Every** to set the number of measurements done by the unit before a value (measurement) is actually stored in the Datalogger when **Continuous** capture mode is enabled (Page 66).

4.9.2 Record operator actions

History

When you enable history the Datalogger will register the unit settings for each measurement that is stored. Information such as gain, trigger, velocity and calibration settings are stored along with the thickness value. This data can only be viewed in DataCenter. When history is enabled the unit memory capacity decreases as more data is stored.



Touch  on **History** to enable or disable this option and touch  to exit.

4.9.3 Record date and time

Clock

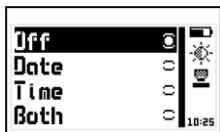
Touch  on **Clock** to set the time and date options that will be recorded by the Datalogger each time a new batch is opened.



Touch   to scroll all menu options and touch  to select and exit.

Touch  to exit without making changes.

Figure 4.21: Record date and time in the Datalogger

Off: The Datalogger does not record date and time.

Date: Each time a new batch is opened the Datalogger records the date.

Time: Each time a new batch is opened the Datalogger records the time.

Both: Each time a new batch is opened the Datalogger records the date and time.

Tips on how to measure correctly

Do not measure outside the thickness range specified for the transducer that you are using.

Use just enough coupling gel to ensure stable measurements. Avoid using excessive coupling gel as it may be added to the thickness value of the actual test piece being measured.

Always do the zero calibration using the calibration disk located in the front of the unit particularly when changing transducers.

Have a reference test piece of the same material that you will be measuring and know the velocity of the material or its thickness value so that you can precisely determine the velocity of the material based on its thickness.

Gain and trigger levels are set from factory with the optimal values that correspond to the transducer that was shipped with your unit. When a transducer is changed gain and trigger levels should be adjusted to optimize transducer functionality.

Technical Specifications

Measuring principal	Pulse-Echo / Echo-Echo
Measuring range	0.6 mm to 500 mm (Pulse-Echo) 2.5 mm a 20 mm (Echo-Echo)
Transducer frequency	2 to 10 MHz
Capture speeds	4, 8 and 20 Hz
Pulser tension	Adjustable 20 V to 210 V
V-Path	Automatic correction
Units	Millimeters, Inches and Microseconds
Resolution	0.01 mm from 0.60 to 99.99 mm 0.1 mm from 100.0 mm and above 0.001 in from 0.040 to 9.999 0.01 in from 10.00 in and above
Material velocity	100 to 19999 m/S 3.937 to 787.3 in/ms
Calibration	Auto, 1-Point and 2-Point
Alarms	Defects, Min., Max. Audible and visual
Languages	English, Spanish, Portuguese
Datalogger	Capacity of 32000 values organized in up to 8 files with alphanumeric names. Manual, Single, Continuous capture modes. Record Date and Time. View data including statistics in grid or graphic formats.
Connection to PC	USB native or RS232 (optional)

Display	Graphic LCD 128 x 64 pixels with LED backlight illumination and contrast adjustment.
Keypad	Touch-sense with no mechanical parts and sensitivity adjustment.
Battery life	100 hours with 2 each type AA batteries
Operating temp.	- 10°C to + 50°C
Enclosure	High impact ABS with rubber sides. Size is 78 x 117 x 24 mm.
Weight	200 g with batteries

Additional information

Unit maintenance

The QS5 was developed and manufactured for years of trouble free operation and even though the unit does not require special care the following precautions should be considered:

- Avoid contact with corrosive and abrasive substances.
- Do not clean the unit with solvents.
- Do not leave the unit display exposed to direct solar light for prolonged periods of time as this could damage the display.
- Remove the batteries if the unit will be stored for an extended period of time.
- Remove the transducer using the connectors and not the cable.
- Do not twist or strangle the transducer cables.
- Do not expose the unit to temperatures below -10°C / 14°F or above 50°C / 122°F .

QS5 Accessories

dmq part No.	Description
QSM 300	Small high impact carrying case
QSS 201	2Mhz transducer – 15 mm diameter
QSS 501	5Mhz standard transducer – 10 mm diameter
QS5 501 HD	5MHz Hi-Damp transducer – Thru-Paint
QSS 701	7Mhz transducer – 5 mm diameter
QSR 161	6 step calibration block (mm)
QSR 141	4 step calibration block (in)
QSG 001	Coupling gel
QSL 102	QS5 B to QS5 DL upgrade license
QSL 301	QS5 E to QS5 DLE upgrade license
QAC 002	RS232 cable to connect to a PC
QAC 003	RS232 cable to connect to a printer

For additional information and accessories for your QS5 visit www.demeq.com/Accessories-QS.html

Error messages

Error messages may eventually open on your unit screen and are informational only. If one of these messages opens on your display follow the instructions described below and if the problem persists please send us a detailed report at www.demeq.com/form_Support.html

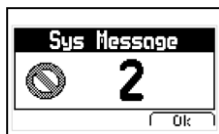

Figure A.2: System error message

Error 1	Internal Error
Cause	Internal Error
Solutions	Shutdown the unit, wait a few seconds, and power back on. Contact dmq.

Error 2	Attempt to store a value over an existing value.
Cause	Improper unit shutdown (Example: Removing batteries) and powering the unit back on to store values in the Datalogger.
Solution	Download Datalogger values to PC or printer and erase memory.

If a message with a different number appears on your unit display please contact dmq immediately.

Our website: www.demeq.com

Our website is a powerful customer support tool where you will find the latest information as it relates to your QS5 including:

- Application notes
- Manuals and brochures
- Software updates
- Model upgrade license information
- New accessories

Software updates

To download software updates to your QS5 you must have dmq DataCenter installed on your PC. To download the latest updates for your unit refer to www.demeq.com/Download.html

Technical support

Our service department is committed to providing prompt and courteous service. Should you encounter any trouble with your QS5 please send us a detailed description of your problem to www.demeq.com/form_Support.html

